

YAMAHA

POWER AMPLIFIER
AMPLIFICATEUR DE PUISSANCE
ENDSTUFE

P2160

OPERATION MANUAL
MODE D'EMPLOI
BEDIENUNGSANLEITUNG

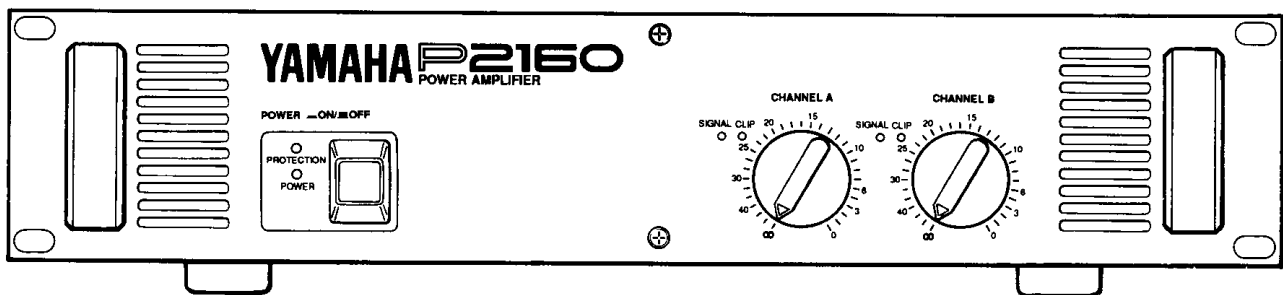

Thank you for purchasing the Yamaha P2160 Power Amplifier.

The P2160 is a high-output power amplifier which is highly stable, very reliable, and housed in a compact, lightweight body.

The P2160 features a full course of Yamaha technology. For example, safe and stable operation is further ensured by DC sensing circuitry which continuously monitors the amplifier's output, combined with other protection functions such as overheating detection, PC limiter circuitry, and a power ON/OFF mute function.

Read this operation manual thoroughly in order to take full advantage of the P2160's performance capabilities and to ensure continued enjoyment in years to come.

CONTENTS

PRECAUTIONS	2
OPERATION	3
RACK MOUNTING	6
CAUTION FOR SPEAKER CONNECTION	9
SPECIFICATIONS	10
DIMENSIONS	11
PERFORMANCE GRAPHS	12
TROUBLESHOOTING	13
BLOCK DIAGRAM	14

PRECAUTIONS

1. Avoid Excessive Heat, Humidity, Dust and Vibration

Keep the unit away from locations where it is likely to be exposed to high temperatures or humidity — such as near radiators, stoves, etc. Also avoid locations which are subject to excessive dust accumulation or vibration which could cause mechanical damage.

2. Avoid Physical Shocks

Strong physical shocks to the unit can cause damage. Handle it with care.

3. Do Not Open The Case Or Attempt Repairs Or Modifications Yourself

This product contains no user-serviceable parts. Refer all maintenance to qualified Yamaha service personnel. Opening the case and/or tampering with the internal circuitry will void the warranty.

4. Make Sure Power Is Off Before Making Or Removing Connections

Always turn the power OFF prior to connecting or disconnecting cables. This is important to prevent damage to the unit itself as well as other connected equipment.

5. Handle Cables Carefully

Always plug and unplug cables — including the AC cord — by gripping the connector, not the cord.

6. Clean With a Soft Dry Cloth

Never use solvents such as benzine or thinner to clean the unit. Wipe clean with a soft, dry cloth.

7. Always Use the Correct Power Supply

Make sure that the power supply voltage specified on the rear panel matches your local AC mains supply. Also make sure that the AC mains supply can deliver more than enough current to handle all equipment used in your system.

IMPORTANT NOTICE FOR THE UNITED KINGDOM

Connecting the Plug and Cord

IMPORTANT. The wires in this mains lead are coloured in accordance with the following code:

BLUE : NEUTRAL

BROWN : LIVE

As the colours of the wires in the mains lead of this apparatus may not correspond with the coloured markings identifying the terminals in your plug proceed as follows:

The wire which is coloured BLUE must be connected to the terminal which is marked with the letter N or coloured BLACK.

The wire which is coloured BROWN must be connected to the terminal which is marked with the letter L or coloured RED.

Making sure that neither core is connected to the earth terminal of the three pin plug.

OPERATION

■ FRONT PANEL

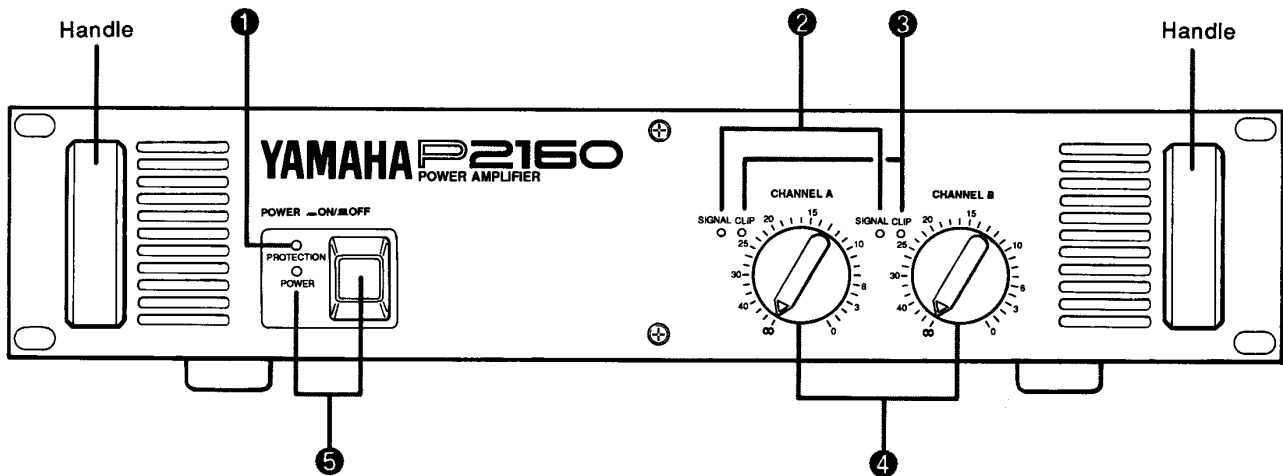

① PROTECTION Indicator

The PROTECTION indicator lights for approximately 6 seconds after the POWER switch is pressed to indicate that the protection circuitry is operating. No sound is output from the speakers while this indicator is lit. This indicator will also light and sound will be cut off to the speakers if the protection circuitry is activated at any other time during amplifier operation due to factors such as overheating or the detection of excessive DC voltage at the outputs. When the problem is corrected, the protection circuitry is automatically deactivated, the indicator goes out, and the amplifier resumes normal operation.

② SIGNAL Indicators

The SIGNAL indicators light when the output level (output voltage at the speaker terminals) exceeds 2 Vrms. This is equivalent to 1/2 watt with an 8 ohm load or 1 watt with a 4 ohm load. A lit SIGNAL indicator indicates that some type of signal is being input to that channel.

③ CLIP Indicators

The CLIP indicators light if the output distortion exceeds approximately 1%. These indicators, which are independently provided for each channel, indicate that an excessively large input signal is being applied to the amplifier causing clipping to occur.

④ Input Attenuators

The input attenuators are 31-position click-stop controls used for adjusting input sensitivity. Rotating fully in the clockwise direction sets the attenuator at 0 dB, while rotating fully in the counterclockwise direction provides infinite attenuation.

⑤ POWER Switch & Indicator

Pressing this switch turns the power ON, and pressing again turns the power OFF. The indicator lights when the power is ON.

⑥ Knob Locks (supplied)

Push these locks over the attenuation controls to prevent accidental resetting of the levels. Pull them off again if you need to reset the levels.

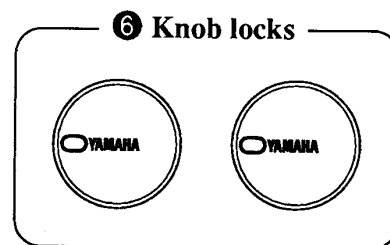

REAR PANEL

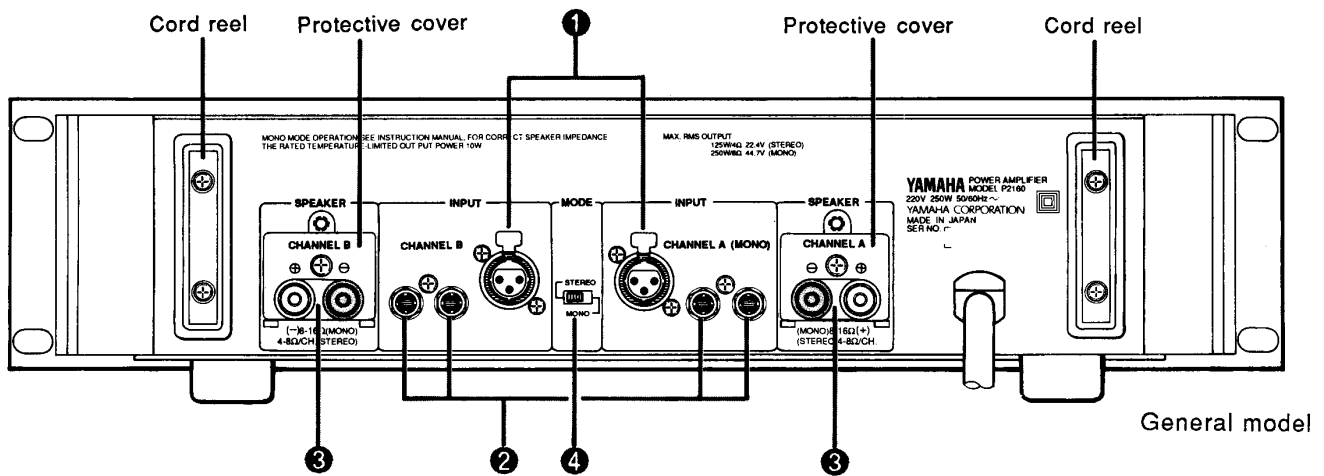
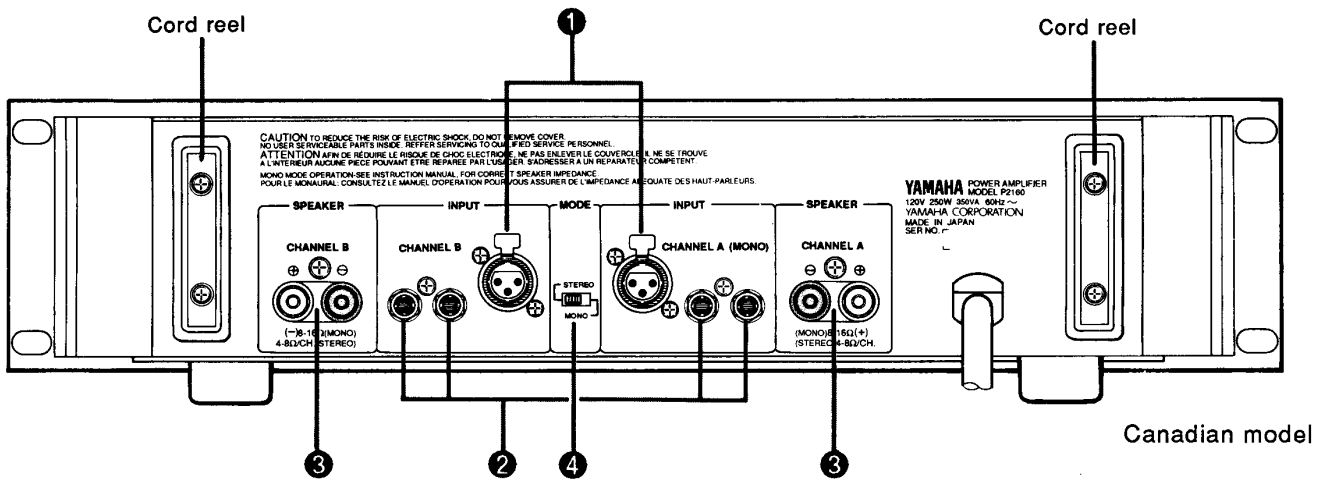
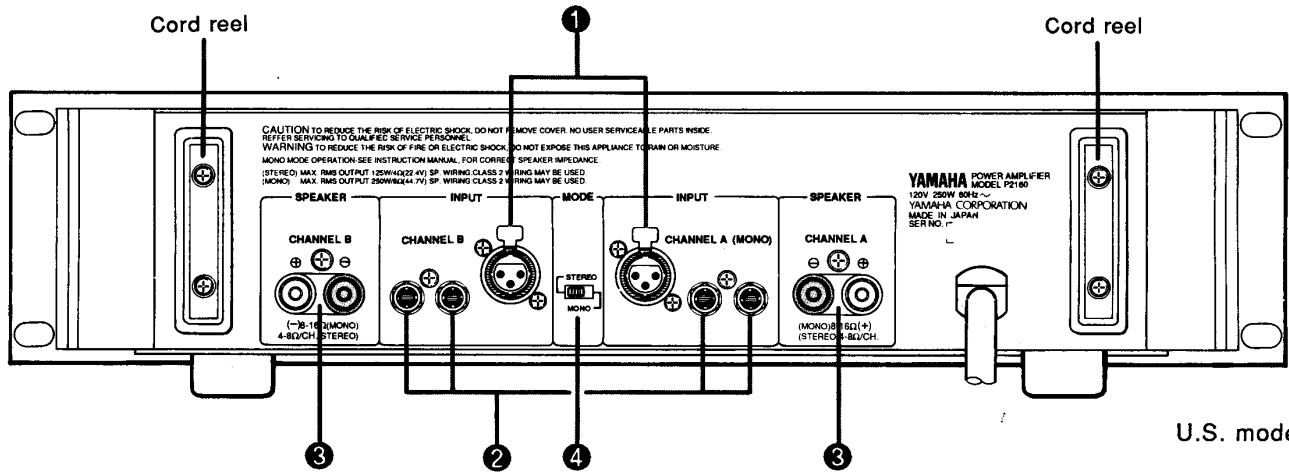

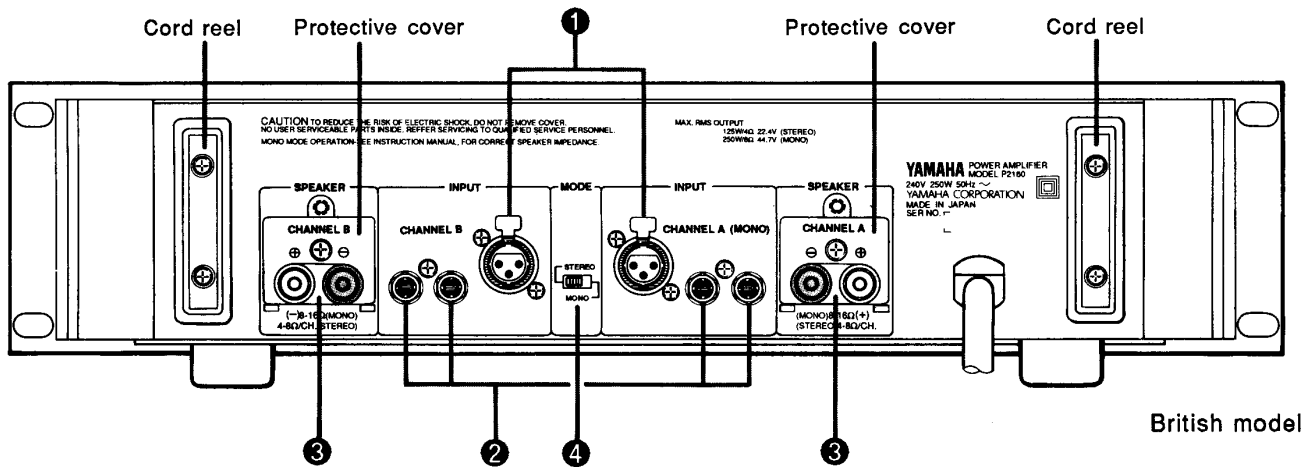

① INPUT Connectors (XLR-3-31 type)

The INPUT connectors are balanced, XLR-3-31 type input connectors. They are wired with Pin 1 as ground, Pin 2 as signal hot, and Pin 3 as signal cold. As connectors, they conform to Cannon XLR-3-12C Switchcraft 5C-1055A standards.

② INPUT Connectors (TRS Phone type)

These 1/4-inch balanced TRS connectors accept balanced and unbalanced input signals. Tip=hot, Ring=cold, Sleeve=ground.

③ SPEAKER Terminals

These are used for connecting the speakers. The red terminal is connected to the speaker's "+" connector and the black terminal is connected to the "-" connector.

Refer to page 9 for details on speaker connection.

④ MODE Switch

This switch sets the amplifier for stereo or monaural operation. Make sure the switch is correctly set for the mode in which the amplifier is to operated.

— Monaural (BTL) Connection —

Although the P2160 is normally used as a stereo amplifier with two independent input and output channels A and B, it is possible to combine the two channels to transform the amplifier into a BTL-connected monaural power amplifier.

— Monaural Operation —

- 1) Turn the POWER switch OFF.
- 2) Set the rear panel MODE switch to MONO.
- 3) Connect the channel A input connector to the signal input source. (The channel B input connector cannot be used.)
- 4) Adjust the input level with the channel A input attenuator.
- 5) Connect the "+" speaker lead to the "+" speaker terminal of channel A, and connect the "-" speaker lead to the "+" speaker terminal of channel B. The "-" speaker terminals on the amplifier are not used.

Note: Use speakers with an impedance of 8 ohms or greater.

RACK MOUNTING

When the amplifier is mounted in a rack, the heat generated by the amplifier heats up the air inside the rack causing the temperature of the amplifier's operating environment to increase. It is therefore necessary for the rack to be well ventilated in order to lower the temperature of the air surrounding the amplifier. Since hot air inside the rack will tend to rise to the top, the most effective ventilation method is to draw air in at the bottom of the rack and expel it from the top.

■ Permanent installation rack mounting:

1. Install a blank panel above or below each power amplifier and install one fan for every four amplifiers in the rear of the rack at the top in the ceiling of the rack as shown in Fig. 1. Fans should have the same specifications as those mentioned on the next page.
2. Make sure that a space of at least 100 mm exists between the power amplifier's rear panel and the rear of the rack.
3. Place the rack in a well-ventilated location.
4. When a power amplifier is mounted in a rack with other types of components, be careful that the heat generated by the power amplifier does not affect the other components.

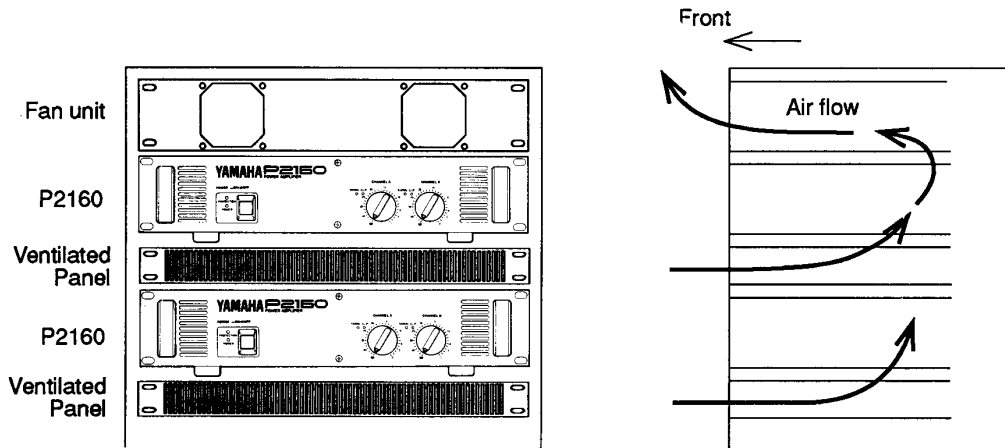
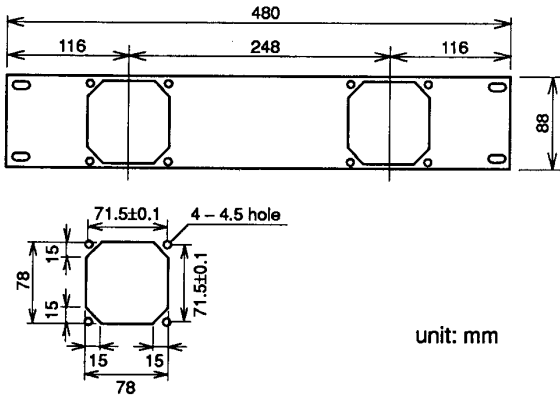

Fig. 1; Rack mounting with cooling fans and ventilated panels

Fan Unit

The fan unit shown uses two fans, each maximum volume of 29 CFM (cubic feet per minute) and a maximum pressure of 5 mm H₂O.



unit: mm

Ventilated Panel

Yamaha VP1 ventilation panel may be provided as an optional accessory (open area should be at least 35% of total area).



unit: mm

CAUTION!

If unit(s) are to be used in a rack mounted installation, it is recommended that fan cooling be installed. Without fan cooling, units could be damaged from excessive temperature conditions.

The minimum required airflow rate for fans should be 2 x 29 cubic feet per minute (CFM). Use only fans with the above specification.

The following are some examples of fans with the proper specifications:

Manufacturer	Type/Model	Airflow Rate
JAPAN SERVO CO LTD.	VS2B4 or equivalent	29 CFM

■ Portable Rack Mounting

- Rules for mounting in portable racks (road cases) are basically the same as for when less than five amplifiers are mounted in a single rack. However, when mounting a power amplifier in a case made for housing only one amplifier, mount a blank panel (ventilated) below the amplifier and make ventilation holes (with a numerical aperture of 0.4 or greater) in the left and right sides of the top panel of the case (corresponding to the amplifier heat sinks) as shown in the illustration at right.

See the dimensions diagram for the exact location of the heat sinks.

- * If a blank panel (ventilated) cannot be mounted in the case, make ventilation holes in the bottom of the case corresponding to the holes in the top, as shown in the illustration at right, and attach legs with a height of at least 20 mm to the bottom to make sure that air can circulate underneath and through the case.

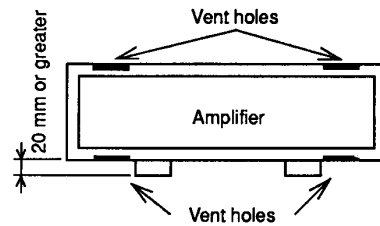
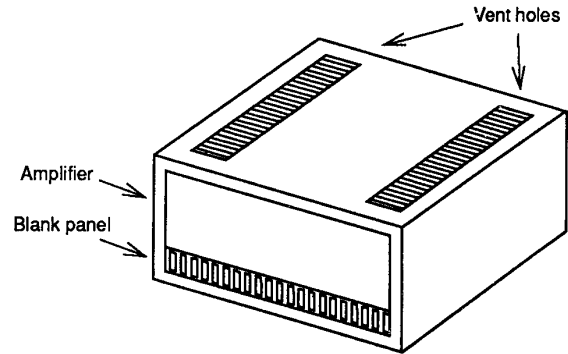

- Positioning the housed amplifier

Place the case so that the ventilation airflow paths are not blocked.

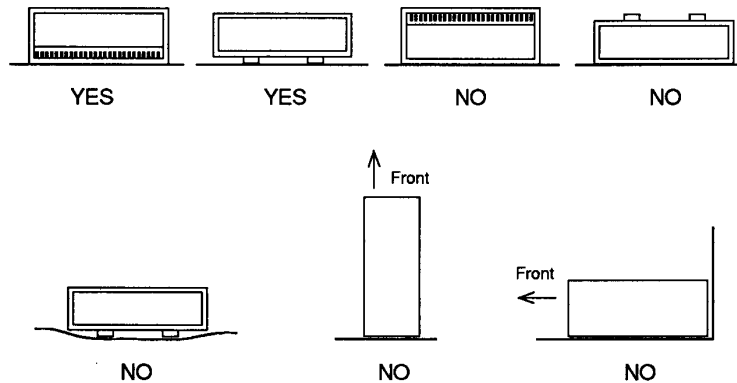

- Rear support

Screw holes are provided in the rear of the amplifier for use in supporting the rear of the amplifier.

- * See the dimensions (page 11) for screw hole positions.

CAUTION FOR SPEAKER CONNECTION

1. Turn off the POWER switch.
2. Remove the cover attachment screws and remove the protective covers from the speaker terminals.
 - * The protective covers are equipped with British model and general model.

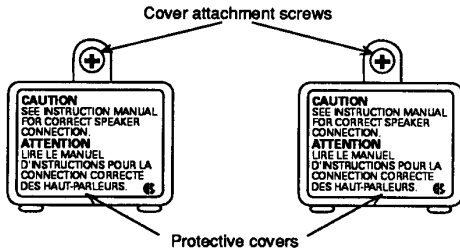

3. After removing approx. 10 mm of covering insulation from the ends of the speaker cables, pass the bare ends of the speaker wires through the holes in the corresponding speaker terminals and tighten the terminals to securely clamp the wires.

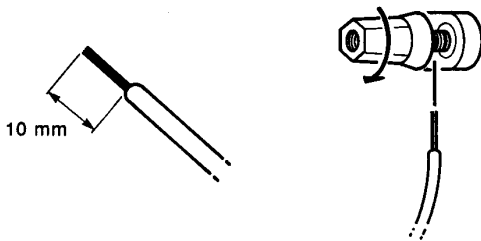

At this time make sure that the bare ends of the speaker cables do not extend from the terminals in such a way that they touch the chassis or protective cover.

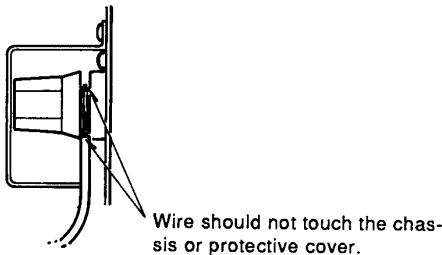

4. Reattach the protective covers over the speaker terminals.

— Speaker output terminals —

Connect the amplifier's A channel and B channel speaker terminals to the corresponding speakers. Make sure that the red terminals on the amplifier are connected to the "+" terminals on the speakers, and that the black terminals are connected to the "-" terminals on the speakers.

Take care that the end of each speaker cable does not short with another end of the speaker cable or with the chassis or protective cover, and then secure the wire in place by tightening down the terminal. Also, always make sure that the power is OFF before attaching or removing speaker wires.

- If long speaker cables are required, use cables with as heavy a gauge as possible to protect against degradation caused by the damping factor and to prevent power loss inside the speaker cables.
- Since P2160 can provide a high power output of up to 80 W + 80 W with 8 ohm load when operating as a stereo amplifier, and up to 250 W with 8 ohm load when operating as a monaural amplifier, it is necessary to use a speaker system with sufficient power handling capabilities. If the allowable input power of the speaker system is lower than the rated output power of the amplifier, you can protect the speakers by connecting an in-line fuse between each speaker and the amplifier.

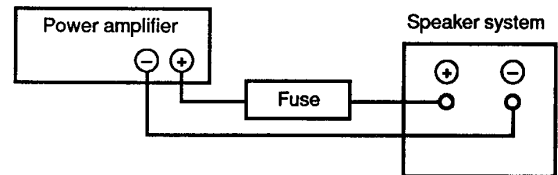

- * You can use the following formula to determine the size of fuse needed for your system.

$$P_o = I^2 R \rightarrow I = \sqrt{\frac{P_o}{R}}$$

P_o : Continuous allowable input power of speaker (noise or RMS)

R : Nominal impedance of speaker

I : Necessary fuse capacity (A)

Example: Speaker continuous allowable input power ; 50 W
Speaker impedance ; 8 ohm
Using these values.

$$I = \sqrt{\frac{50}{8}} = 2.5$$

Necessary fuse capacity (A) = 2.5

SPECIFICATIONS

POWER OUTPUT LEVEL

STEREO:

80W + 80W; RL = 8 ohms, f = 20 Hz — 20 kHz, THD ≤ 0.1 %
125W + 125W; RL = 4 ohms, f = 20 Hz — 20 kHz, THD ≤ 0.1 %

MONO:

250W; RL = 8 ohms, f = 20 Hz — 20 kHz, THD ≤ 0.1 %

FREQUENCY RESPONSE

0 dB ±1.0 dB; f = 10 Hz — 50 kHz, RL = 8 ohms, Po = 1 W

POWER BANDWIDTH

STEREO:

10 Hz — 40 kHz; Po = 40 W, RL = 8 ohms, THD = 0.1 %
10 Hz — 40 kHz; Po = 63 W, RL = 4 ohms, THD = 0.1 %

MONO:

10 Hz — 40 kHz; Po = 125 W, RL = 8 ohms, THD = 0.1 %

TOTAL HARMONIC DISTORTION (THD)

STEREO:

≤0.05%; Po = 40 W, RL = 8 ohms, f = 20 Hz — 20 kHz
≤0.07%; Po = 63 W, RL = 4 ohms, f = 20 Hz — 20 kHz

MONO:

≤0.07%; Po = 125 W, RL = 8 ohms, f = 20 Hz — 20 kHz

INTERMODULATION DISTORTION (IMD)

STEREO:

≤0.03%; Po = 40 W, RL = 8 ohms, f = 60 Hz : 7 kHz, 4 : 1
≤0.05%; Po = 63 W, RL = 4 ohms, f = 60 Hz : 7 kHz, 4 : 1

MONO:

≤0.05%; Po = 125 W, RL = 8 ohms, f = 60 Hz : 7 kHz, 4 : 1

CHANNEL SEPARATION

ATT max, Input 600 ohms shunt

≥ 68 dB; Po = 40 W, RL = 8 ohms, f = 20 Hz — 20 kHz

RESIDUAL NOISE

≤ -70 dBm; ATT min, fc = 12.7 kHz -6 dB/oct LPF
≤ -75 dBm; ATT min, IHF-A network

SIGNAL-TO-NOISE RATIO

≥ 100 dB; Input 600 ohms shunt, fc = 12.7 kHz -6 dB/oct LPF
≥ 105 dB; Input 600 ohms shunt, IHF-A network

DAMPING FACTOR

> 100; RL = 8 ohms, f = 1 kHz

SLEW RATE

± 30 V/μ sec; Stereo, RL = 8 ohms, Full Swing
± 50 V/μ sec; Mono, RL = 8 ohms, Full Swing

SENSITIVITY

+ 4 dBm; Po = 80 W, 8 ohms, ATT max, f = 1 kHz

VOLTAGE GAIN

26.3 dB; ATT max, f = 1 kHz, RL = 8 ohms

INPUT IMPEDANCE

≥ 15 kohms; Balance or Unbalance, ATT max

INDICATORS

POWER	Red LED; turns on when Power is On
PROTECTION	Red LED; turns on when protection or muting is On
CLIPPING	Red LED; turns on when THD ≥ 1 %
SIGNAL	Green LED; turns on when Signal output above 2 Vr.m.s., (means 1 W. 4 ohms) (20 Hz — 20 kHz)

PROTECTION CIRCUITS

OUTPUT MUTING	6 sec. ± 2 sec.; after power is on
DC sense	DC ± 2 V; output shut off
THERMAL	≥85 degree C.; heat sink temp.
PC LIMITER	RL ≤ 2 ohms

CONTROLS

FRONT

POWER SWITCH ; push on/ push off
INPUT ATTENUATOR; 31-position

REAR

MODE SWITCH; Stereo/Mono (BTL)

POWER REQUIREMENTS

U.S. & Canadian Models; 120 V, 60 Hz
General Model; 220/240 V, 50/60 Hz
British Model; 240 V, 50 Hz

POWER CONSUMPTION

U.S. Model; 250 W
Canadian Model; 250 W/350 VA
General Model; 250 W
British Model; 250 W

DIMENSIONS (W x H x D)

480 x 98 x 398 mm (18-7/8" x 3-7/8" x 15-11/16")

WEIGHT

10.5 kg (23 lbs. 2 oz)

* 0 dB = 0.775 Vr.m.s.

* Specifications and appearance subject to change without notice.

DIMENSIONS

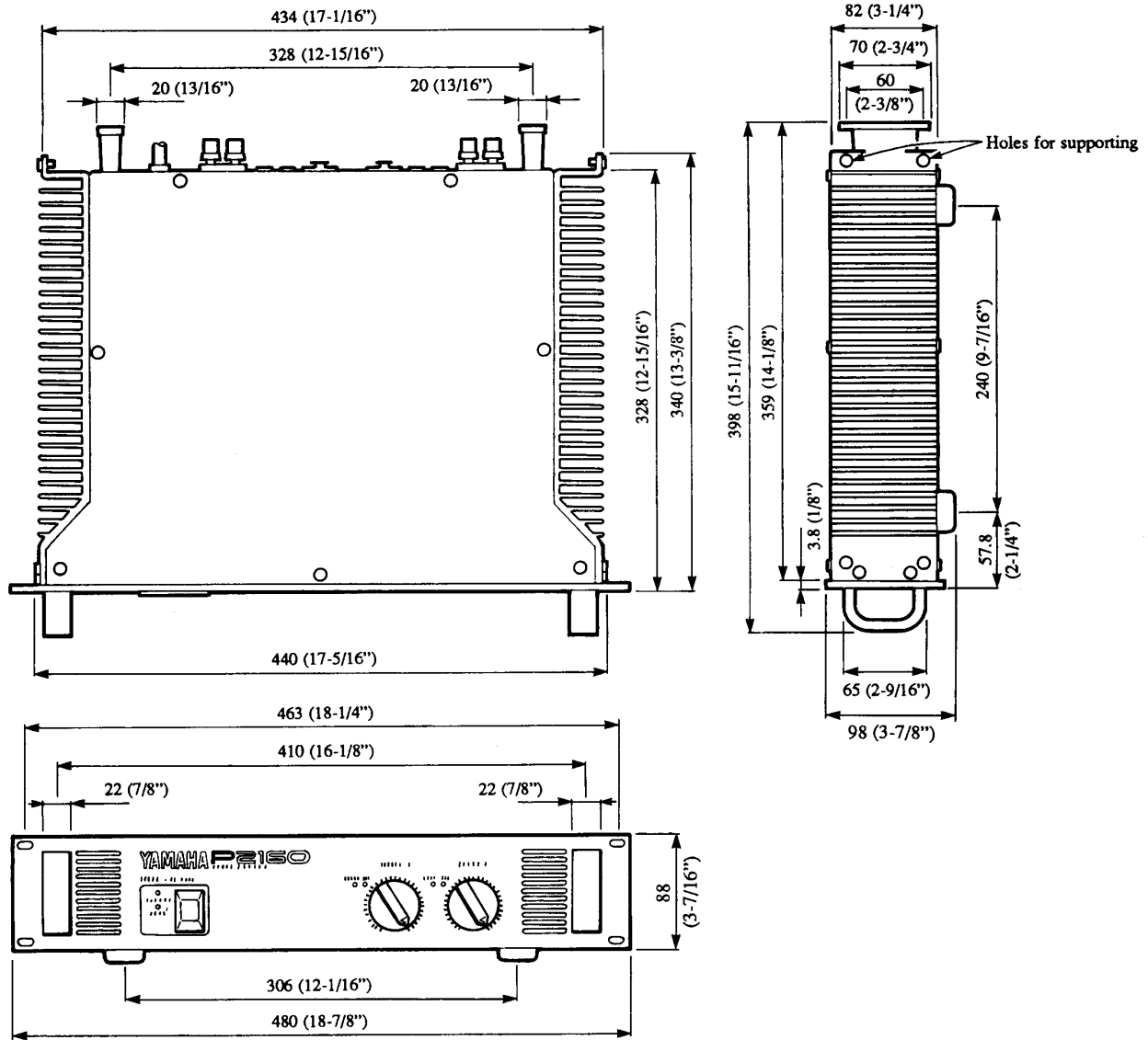

Unit: mm (inch)

PERFORMANCE GRAPHS

FREQUENCY RESPONSE

Load Impedance: 8Ω
 Input Attenuators: Max
 Mode: STEREO
 0 dB = 1W

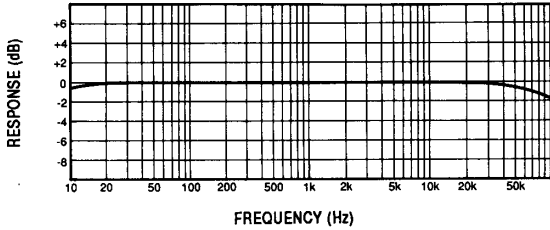

OUTPUT POWER vs POWER CONSUMPTION

Mode: STEREO
 Both Channels Driven

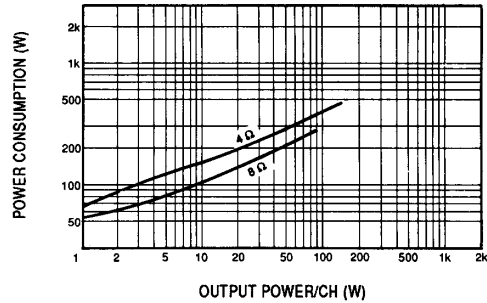

THD vs OUTPUT POWER

Load Impedance: 8Ω
 Mode: STEREO
 Both Channels Driven

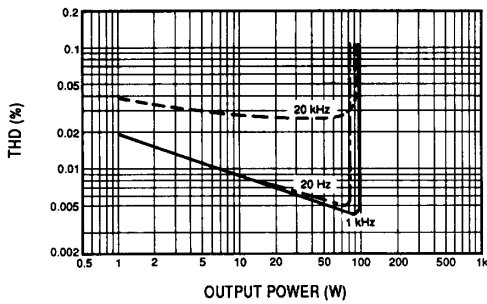

THD vs FREQUENCY

Load Impedance: 8Ω
 Mode: STEREO
 Both Channels Driven
 Output Power: 40W constant

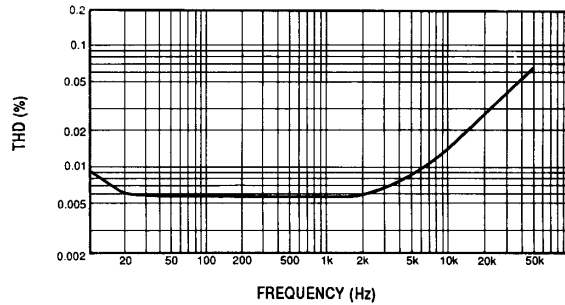

THD vs OUTPUT POWER

Load Impedance: 4Ω
 Mode: STEREO
 Both Channels Driven

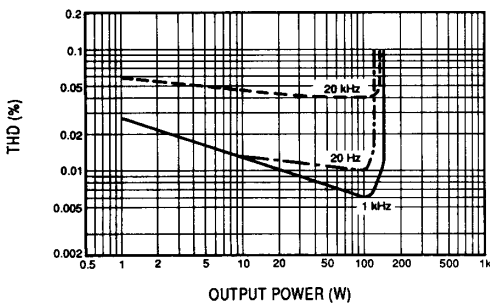

THD vs FREQUENCY

Load Impedance: 4Ω
 Mode: STEREO
 Both Channels Driven
 Output Power: 63W constant

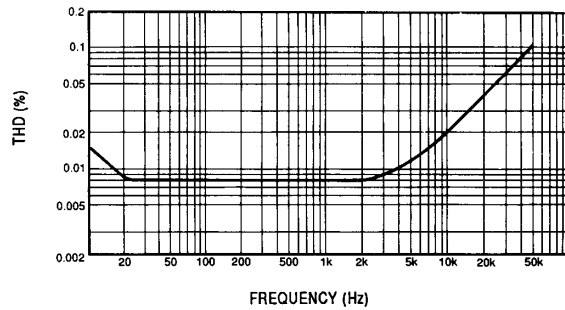

THD vs OUTPUT POWER

Load Impedance: 8Ω
 Mode: MONO (BTL)

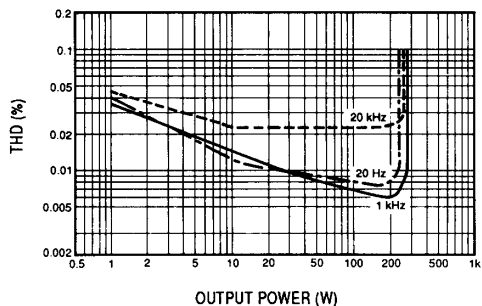

THD vs FREQUENCY

Load Impedance: 8Ω
 Mode: MONO (BTL)
 Output Power: 125W constant

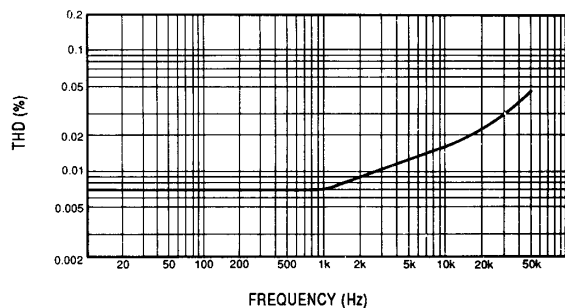

DAMPING FACTOR

Load Impedance: 8Ω
Mode: STEREO

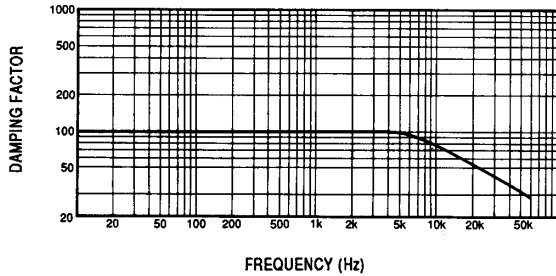

CHANNEL SEPARATION

Load Impedance: 8Ω
0 dB = 40W constant
Measuring Channel
Input 600Ω Shunt

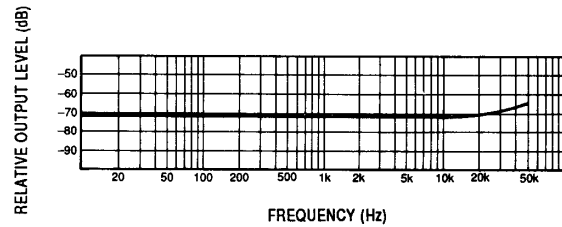

TROUBLESHOOTING

The following table lists the main causes of abnormal operation and the corrective measures required, as well as the protective circuit operation in each case.

Indicator display	Probable cause	Remedy	Protective circuit operation
CLIP indicator lights.	There is a short at a speaker terminal, amplifier terminal, or wire.	Locate and correct the cause of the short.	The PC limiter circuit operates to protect the power transistors.
	The amplifier load is excessive.	Use a speaker system with an impedance of at least 4 ohms (stereo) or 8 ohms (monaural).	Same as above.
PROTECTION indicator lights.	The heat sink temperature has exceeded 100°C.	Check the amplifier ventilation conditions and take appropriate measures to improve airflow around the amplifier.	The thermal protection circuit operates to protect the power transistors.
	A DC voltage of +/-2V or greater was generated in the power amplifier's output circuit.	Consult your dealer or nearest Yamaha service center.	The relay operates to protect the speaker system.

BLOCK DIAGRAM

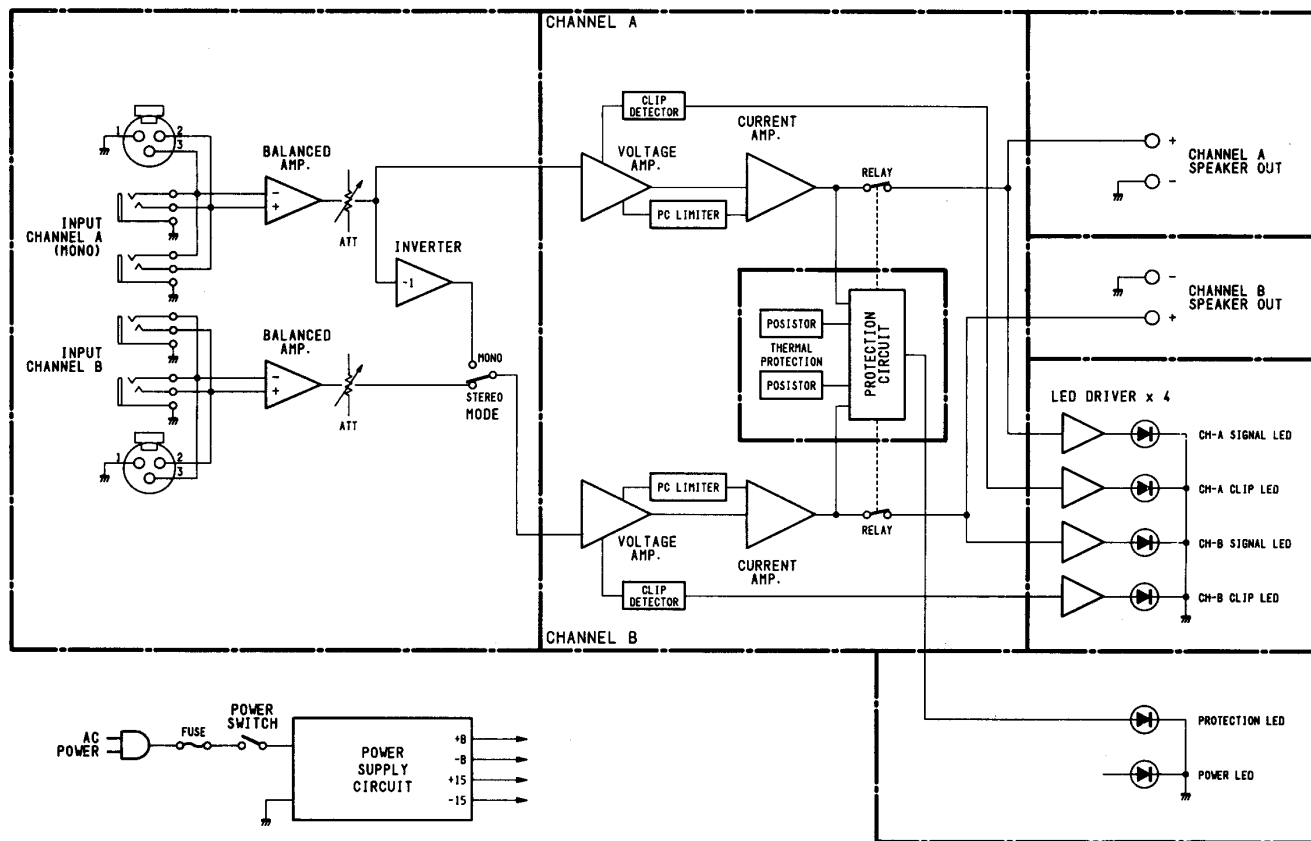

SERVICE

This product is supported by YAMAHA's worldwide network of factory trained and qualified dealer service personnel. In the event of a problem, contact your nearest YAMAHA dealer.

ENTRETIEN

L'entretien de cet appareil est assuré par le réseau mondial YAMAHA de personnel d'entretien qualifié et formé en usine des concessionnaires. En cas de problème, prendre contact avec le concessionnaire YAMAHA le plus proche.

KUNDENDIENST

Für dieses Gerät steht das weltweite YAMAHA Kundendienstnetz mit qualifiziertem, werksgeschultem Personal zur Verfügung. Bei Störungen und Problemen wenden Sie sich bitte an Ihren YAMAHA-Händler.

YAMAHA